

Drop-In Drop-in remote refrigerated well, static (1 GN container capacity)

ITEM # _____

MODEL # _____

NAME # _____

SIS # _____

AIA # _____

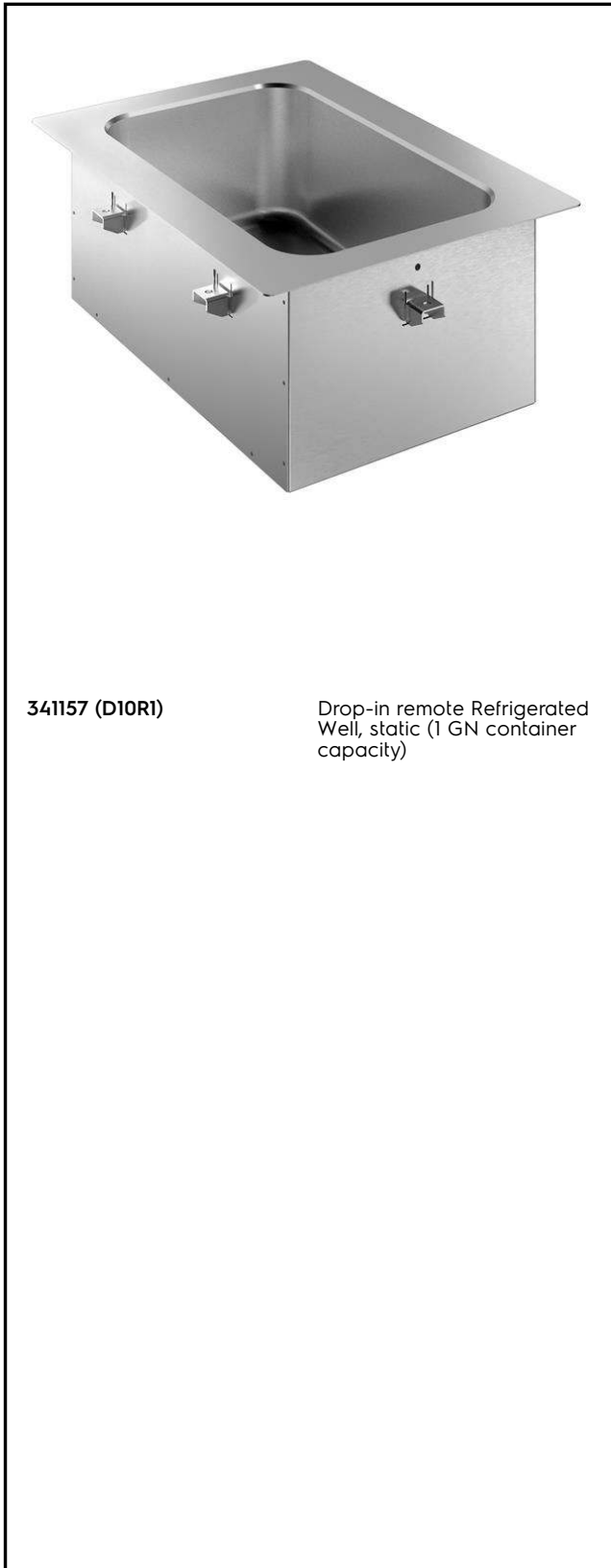

341157 (D10R1)

Drop-in remote Refrigerated Well, static (1 GN container capacity)

Main Features

- Preadjusted connection to remote cooling unit (not included).
- CB and CE certified by a third party notified body.
- Designed to be positioned in flush installation providing improved cleanability and suitable for modern design installations.
- Designed to serve the food in gastronorm containers.
- Suitable for GN 1/1 containers with a maximum height of 200 mm.
- Precise temperature control and setting at 0,1°C .
- As standard the product comes with digitally controlled thermostat which is in line of HACCP norms and provides visual alarm as a warning of the increasing or decreasing temperatures.
- Available drop-in dimensions: 1, 2, 3, 4, 5, 6 GN.
- Food introduced at the correct temperature maintains its core temperature according to Afnor Standards.
- Automatic defrosting guarantees evaporators clearance and efficient well cooling.
- Built-in cooling unit version is available.

Construction

- Well bottom is inclined to facilitate water drainage.
- Environmentally friendly: R452a as refrigerant gas.
- Well in 304 AISI stainless steel with rounded corners to facilitate cleaning operations. The well is also equipped with a drain hole.
- Electronic control with temperature display.
- IPx2 water protection.
- The bottom is equipped with copper tubes to ensure proper cooling, with this system the air touches the cold surface and gets cooled.

Sustainability

- High-density expanded polyurethane foam with cyclopentane guarantees excellent well insulation to reduce energy dispersion.



APPROVAL: _____

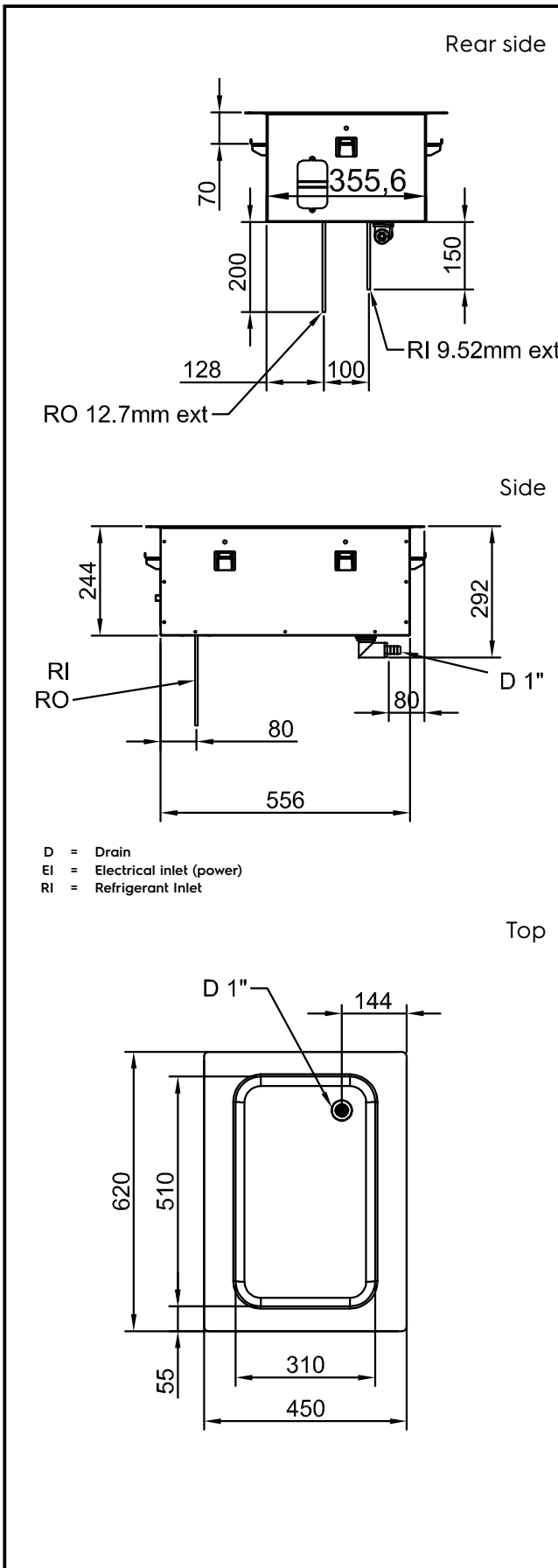

Electric

Supply voltage:
341157 (D10R1) 220-240 V/1N ph/50 Hz

Electrical power max.: 0.055 kW

Water:

Water drain outlet size: 1"

Key Information:

External dimensions, Width: 450 mm
 External dimensions, Depth: 620 mm
 External dimensions, Height: 260 mm
 Net weight: 22.5 kg
 Shipping weight: ISO 9001; ISO 14001 kg
 Shipping height: 720 mm
 Shipping width: 490 mm
 Shipping depth: 660 mm
 Shipping volume: 0.23 m³
 Set temperature: -15 / 0 °C

Refrigeration Data

Refrigerant type: R452A
 Connection pipes (remote) - outlet: 12.7 mm
 Connection pipes (remote) - inlet: 9.52 mm

Sustainability

Noise level: 0 dBA

Drop-In
Drop-in remote refrigerated well, static (1 GN container capacity)

The company reserves the right to make modifications to the products without prior notice. All information correct at time of printing.

2024.07.03

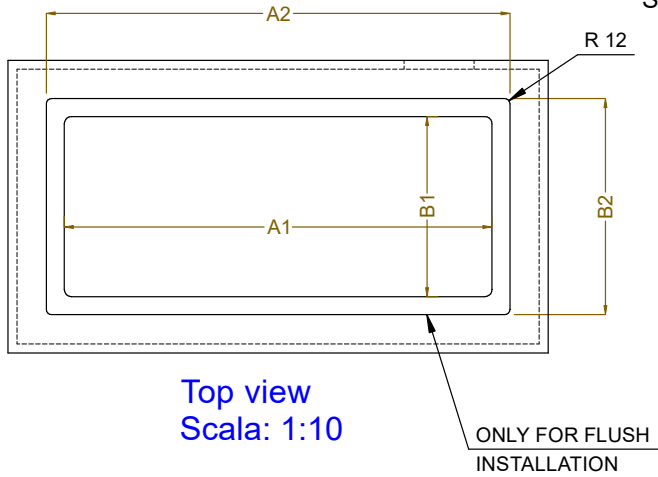
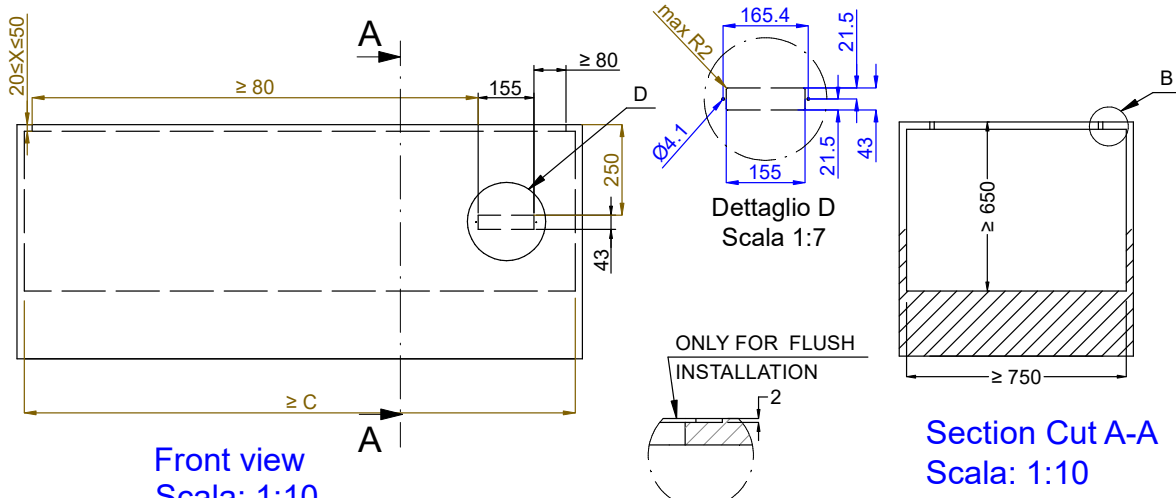

CAPACITY	CUTOUT		LOWERING FOR FLUSH INSTALLATION		C
	A1	B1	A2	B2	
1GN	380	580	454	624	560
2GN	700		774		880
3GN	1030		1104		1200
4GN	1350		1424		1530
5GN	1670		1744		1850
6GN	2000		2074		2180

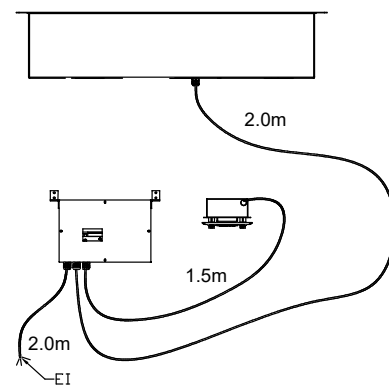
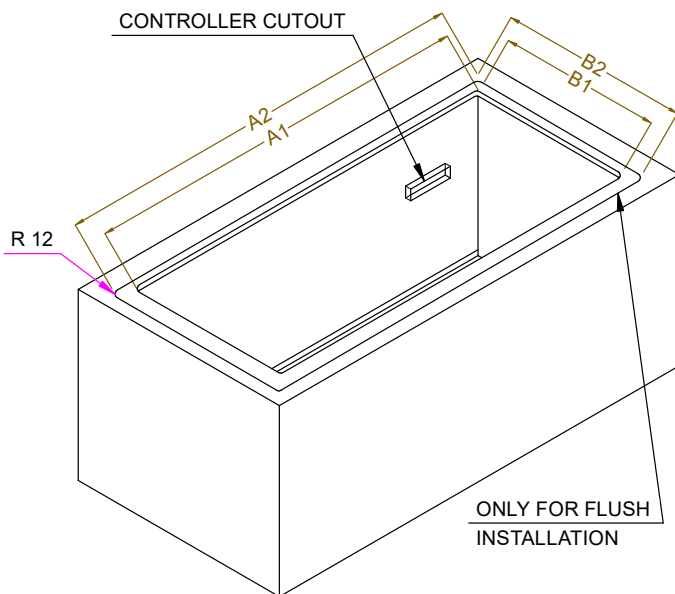

595T02100 - COLD STATIC WELL REM.